



www.uapac.com

1751 East Del Amo Blvd, Carson, CA 90746

Tel: (310) 638-5988 / Fax: (310) 638-6287

Toll Free: (800) 790-6988

sales@uapac.com

 Know It First. Follow Us on FACEBOOK
Type "UNITED PACIFIC INDUSTRIES"

UCTH2

TRAIN HORN & AIR COMPRESSOR
PRODUCT CATALOG - 2ND EDITION



710270095186

© United Pacific Industries, Carson, CA 90746, All Rights Reserved.

Printed in China

TRAIN HORN & AIR COMPRESSOR PRODUCT CATALOG

2ND EDITION

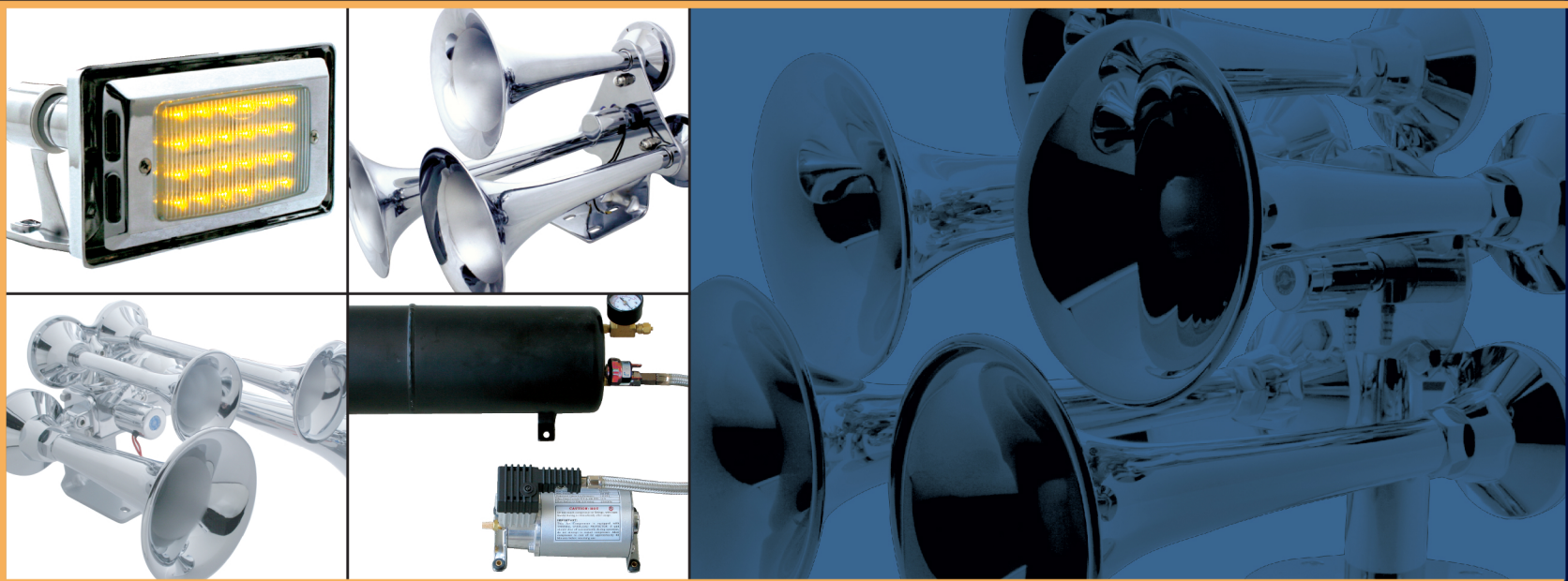

Quality.

Innovation.

Design.

MISSION STATEMENT

Here at United Pacific, we are dedicated to providing today's drivers with innovative and exciting products that deliver exceptional performance and value. Because United Pacific's continuing success depends on our customer's satisfaction, we constantly push our designers and engineers to upgrade our facilities and processes in order to bring products of superior quality and reliability to the market. We at United Pacific promise to continue our passionate pursuit to be the first in

QUALITY, INNOVATION AND DESIGN.

QUALITY

With over 30 years of experience in the heavy duty trucking industry, United Pacific Industries understand the rigors and stresses that our products are subjected to on the road. It is our mission to provide our customers with products of superior quality and reliability. In achieving this goal, United Pacific only partners with manufacturing facilities that conforms to our quality control requirements and standards. Our manufacturing partners meet or exceed ISO-9001 requirements. In addition, United Pacific's manufacturing partners must be equipped on site to perform the following quality assurance tests:

AGING TEST

AIR TIGHT TEST

DUST TEST

FLUX TEST

PHOTOMETRIC TEST

PULL FORCE TEST

RAIN TEST

SALT SPRAY TEST

SHOCK TEST

TEMPERATURE TEST

HUMIDITY TEST

VIBRATION TEST

United Pacific's manufacturing partners must maintain a track record of consistent quality and low product failure rate. Furthermore, our internal quality control structure allows us to function as the final quality control station prior to shipping. With the assistance of 3D computer technology, United Pacific can adhere to strict quality control standards during prototype creation and the production process. Our engineers and technicians perform a battery of tests to ensure that our products meet the demands of today's drivers and our goal to be first in quality.

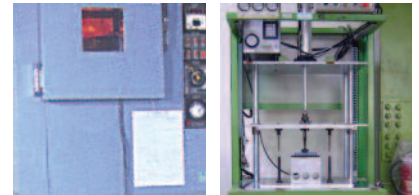



HOW TO ORDER

To order from United Pacific Industries, you must be an authorized dealer, distributor or OEM.

If you are not authorized to stock and sell United Pacific products, you must order through an authorized dealer. Please call 1 (310) 638-5988 for more information.

CONTACT US

United Pacific customer service representatives are available from:

8 am - 4:30 pm PST

Toll Free: 1 (800) 790-6988
 Phone: 1 (310) 638-5988
 Fax: 1 (310) 638-6287
 Email: sales@uapac.com
 Website: www.uapac.com

INNOVATION

Known as the leader in innovation, United Pacific is dedicated to be the first to bring new and exciting products to the market. United Pacific's global expertise allows us to search the globe for new ideas and concepts. Not only do we search the globe for new products, United Pacific invest a significant amount of resources into our own research and development efforts.



With the assistance of advance 3D scanning technology, our engineers and designers can acquire accurate and precise data in seconds. The 3D data allows United Pacific to verify designs, perform quality assurance tests, and reverse engineer with unprecedented speed and accuracy. Digital inspection contributes to the early detection of shape problems, provides rapid feedback on design, and eliminates unnecessary work in downstream processes. Our rapid prototyping facility permits us to have a concept-to-shelf time of less than 5 months.



In addition, United Pacific's 3D printing capabilities permit our designers to have physical models of their design concepts in hours. The physical models allow our designers and marketing staff to evaluate and test the viability of different design ideas. Our rapid prototyping facility allow United Pacific to compress design cycles, improve manufacturing planning, shorten concept-to-shelf time, most importantly, generate new and innovative products.

DESIGN

Located near some of the nation's most progressive automotive design centers, United Pacific established the UP Design Studio in 2002 to consolidate our position as the design leader in the heavy duty trucking industry. UP Design Studio utilizes the latest generation of computer aided design (CAD) and studio/graphic softwares. The design studio is equipped with the newest computers and rapid prototyping systems. In addition, UP Design Studio is staff by graduates from the nation's most prestigious design colleges.



Unlike our competitors, United Pacific's design and manufacturing capabilities mean that we carry more new and original items than our competitors. The establishment of the design studio will enable us to generate even more new products with significant shorter concept-to-shelf time. The reduction in development cost mean that we can develop products utilizing design based development processes. Design based product development allows United Pacific to create new product concepts base on designs incorporating driver demands and needs instead of economic considerations. United Pacific's emphasis on design distinguishes and positions us ahead of our competitors.



Light Emitting Diodes (LED)

Low voltage Operation

A low voltage device, LEDs draw minuscule amount of current from a vehicle's electrical system compared to incandescent devices. Low voltage draw protects and prolongs a vehicle's electrical system.

Instant On

LEDs light up in microseconds. Research conducted by the University of Michigan Transportation Research Institute indicates that motorist respond quicker to LEDs than incandescent lights.

Rugged & Durable

Being a solid-state device, LEDs contain no moving parts and filaments to break. Produced with similar technologies as the latest microprocessor, LEDs provide unparalleled reliability and dependability.

Cold Start Capacity

Unlike many light sources in use today, LEDs do not require any special drivers or equipment to operate in extreme cold temperature. Solid State technology allows LEDs to function in inhospitable environments, down to -40°.

WARRANTY

With LEDs (Light Emitting Diodes) rated at 100,000 hours of operation and solid-state construction, United Pacific's LED lights are extremely reliable and durable. United Pacific offers a 10 Year Limited Warranty on most LED lights. Economy LED lights are only covered by a 2 Year Limited Warranty. All LED accessory lights are covered by a 6 Month Limited Warranty.



INVENTORY & SHIPPING

United Pacific carries over 20,000 items in our California distribution center. No other company in the heavy duty trucking industry can match United Pacific in the variety and range of in-stock inventories. With an order fill rate of over 98.5%, United Pacific is the largest and most reliable supplier in the industry. Our shipping department ships 96.8% of all orders within 24 hours and 98.9% within 48 hours. United Pacific's vast inventory and prompt shipping has made United Pacific the only source for our customer's chrome and lighting needs.



ASSEMBLED IN U.S.A

United Pacific strives to provide today's drivers with innovative and exciting products that deliver exceptional performance and value. With our international background and expertise, we search the globe for the best and most reliable products. However, as an American company, we believe and support the American way of life. Look for the "Assembled in the USA" label on many of our products. Although the components are manufactured overseas, the products, bearing the "Assembled in the USA" labels, are hand assembled with pride in the United States.



WEBSITE

United Pacific strives constantly to improve our existing facilities and procedures. As a part of our continuous improvement process, United Pacific will soon be updating our website. The new website will be even more comprehensive and in-depth. In addition, we will incorporate an online ordering system that will enable our customers to order and receive shipping updates online. The online ordering system will only be available to authorized retailers. The new website is just another example of United Pacific's ceaseless pursuit to be our customer's only source for their chrome and lighting needs.



Hard at work for our customers

UNITED PACIFIC SHANGHAI

In 2005, United Pacific opened United Pacific Shanghai. Staffed with 3 quality assessment engineers and 2 logistic support personnel, United Pacific Shanghai serves as United Pacific's quality control and logistics office in China. Located in the commercial center of China, the Shanghai office provides United Pacific with unparalleled access to local markets and suppliers. The open access translates into faster product development and more rigorous quality control standards. The opening of the Shanghai office means that there will be a United Pacific employee hard at work for our customers 24 hours a day in different parts of the world.

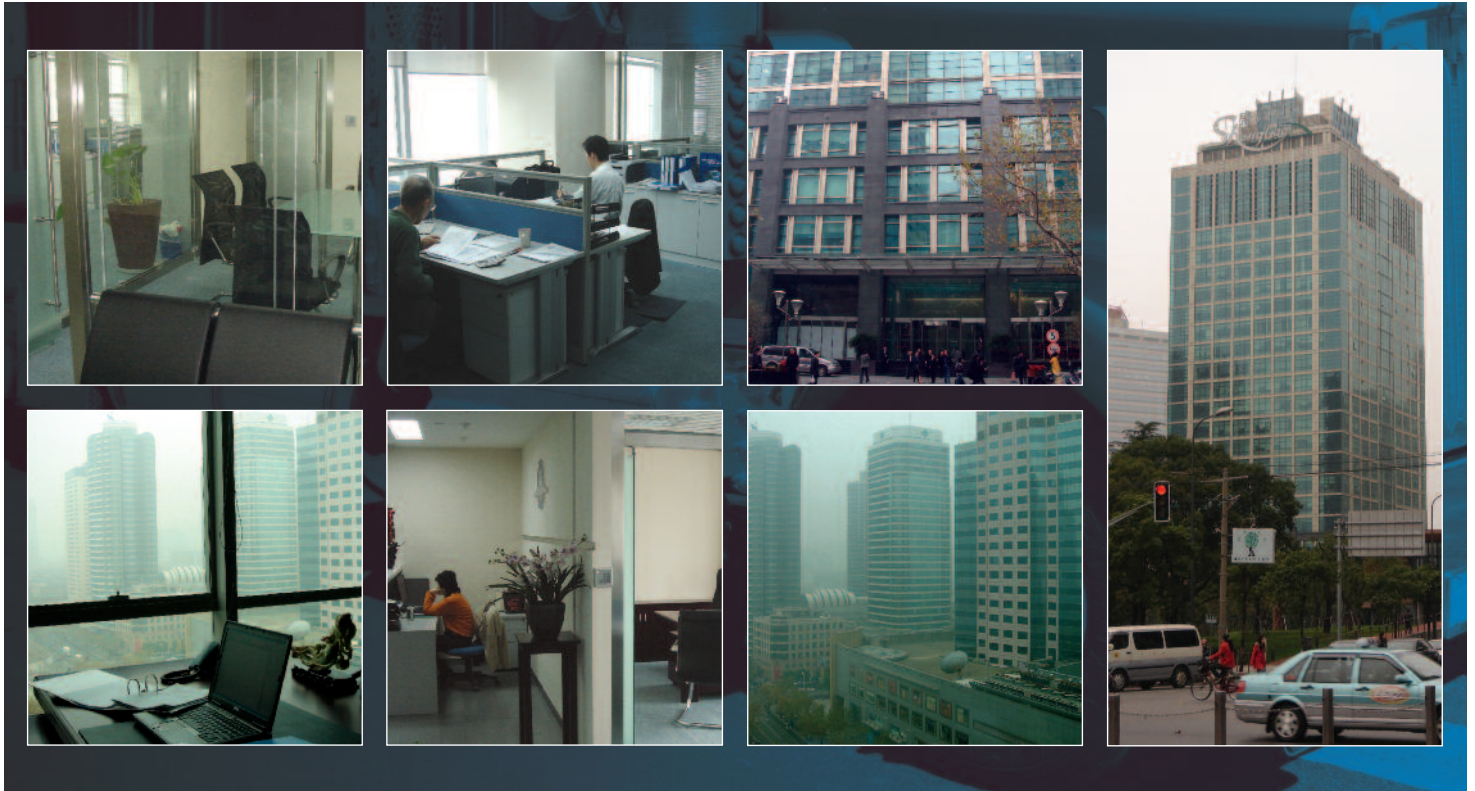

UNITED PACIFIC CHROME PLATING

United Pacific's commitment to quality led United Pacific to invest in its own chrome plating facility. With one chrome plating line fully operational and another in construction, the chrome plating plant will ensure that United Pacific products meet our strict quality control standards. Better products mean better sales for United Pacific customers.

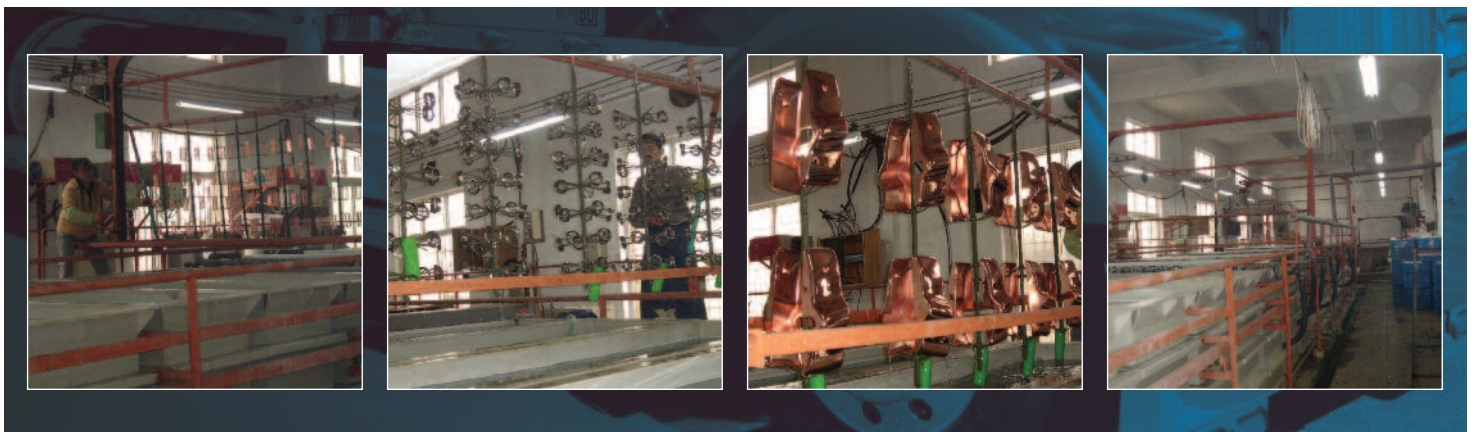

Hard at work for our customers

UNITED PACIFIC JOINT VENTURE

Here at United Pacific, collaboration is at the heart of our business. We partner with manufacturers that are as passionate about well-made and well-designed products as we are. In 2006, United Pacific entered into the ultimate collaboration. United Pacific formed a joint venture with China's largest manufacturer of heavy duty trucking products. The joint venture currently supplies all major American and Canadian aftermarket distributors (including United Pacific competitors) with stainless steel, chrome, and exhaust products. Because of our collaborative approach to product development and manufacturing, we're able to eliminate undue inefficiencies and cost. As a result, United Pacific customers benefit from unique products that are offered at the best possible price and the highest possible quality.

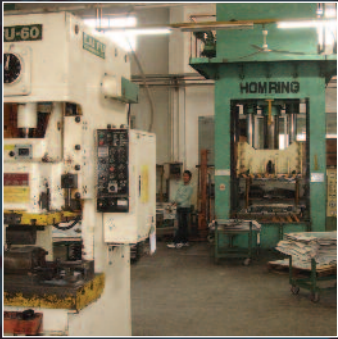

TABLE OF CONTENTS

TRAIN HORN & ACCESSORIES		PAGE
Train Horn Bundle		
Standard Duty Train Horn Bundle		2
Heavy Duty Train Horn Bundle		2
Black Train Horn Bundle		2
Mini Train Horn Bundle		2
Train Horn		
5 Trumpet Chrome Train Horn		3
4 Trumpet Chrome Train Horn		3
3 Trumpet Chrome Train Horn		4
3 Trumpet Black Train Horn		5
Horizontal Train Horn		
8 Trumpet Chrome Horizontal Train Horn		6
7 Trumpet Chrome Horizontal Train Horn		6
6 Trumpet Chrome Horizontal Train Horn		6
3 Trumpet Chrome Horizontal Train Horn		7
Specialty Horn and Whistle		
Single Trumpet LED Air Horn		8
Mini Train Horn		8
Electric Horn		9
Bull Horn		9
Ah-Ooo-Gah Horn		9
Train Whistle		9
Wolf Whistle		9
Horn Cover & Components		
Dome Horn Cover		10
Pointed Horn Cover		10
Rectangular Horn Cover		10
Replacement Horn Trumpets		10
Electric Solenoid Valve		11
Train Horn Diaphragm		11
Train Horn Mounting Hardware Kit		11
Horn Button Switch		11
Air Valve Lever		
Air Valve Lever Set		11
Air Valve Lever		11
Air Valve Stand		11
AIR COMPRESSOR & ACCESSORIES		PAGE
Air Compressor and Accessories		
Air Compressor & Tank Kit		12
Air Compressor		12
Air Pressure Switch		12
Air Storage Tank		12
High Pressure Air Hose		12
Air Blow Gun Kit & Accessories		
Heavy Duty Air Blow Gun Kit		13
Air Blow Gun		13
Recoil Air Hose		13
Brass Connectors		13
REFERENCE		PAGE
Warranty and Terms		14
Product Index		18

Heavy Duty "Classic" Train Horn Bundle**Description**

- Chrome Deluxe 3 Trumpet "Classic" Train Horn (UP Item # 46116) and Heavy Duty Compressor with Tank (UP Item # 46140)
- Kit Includes 1 Train Horn, 1 Turbo Air Compressor, and 5.5 Liter Tank System

Item Number	Description	Pack
46175	Heavy Duty "Classic" Train Horn Bundle	1 Pc./Box

**Train Horn Bundle****Description**

- Chrome 3 Trumpet Train Horn (UP Item # 46129) with Heavy Duty Air Compressor and 5.5 Liter Air Tank (UP Item # 46140)
- Kit Includes 1 Train Horn, 1 Turbo Air Compressor, and 5.5 Liter Tank System

Item Number	Description	Pack
46170	Standard Duty Train Horn Bundle	1 Kit

**Black Train Horn Bundle****Description**

- Black 3 Trumpet Train Horn (UP Item # 46127) with Heavy Duty Air Compressor and 5.5 Liter Air Tank (UP Item # 46140)
- Kit Includes 1 Train Horn, 1 Turbo Air Compressor, and 5.5 Liter Tank System

Item Number	Description	Pack
46172	Black Train Horn Bundle	1 Kit

**Mini Train Horn Bundle****Description**

- Chrome Deluxe 4 Trumpet Mini Train Horn (UP Item # 46123) with Heavy Duty Air Compressor and 5.5 Liter Air Tank (UP Item # 46140)
- Kit Includes 1 Train Horn, 1 Turbo Air Compressor, and 5.5 Liter Tank System

Item Number	Description	Pack
46173	Mini Train Horn Bundle	1 Kit

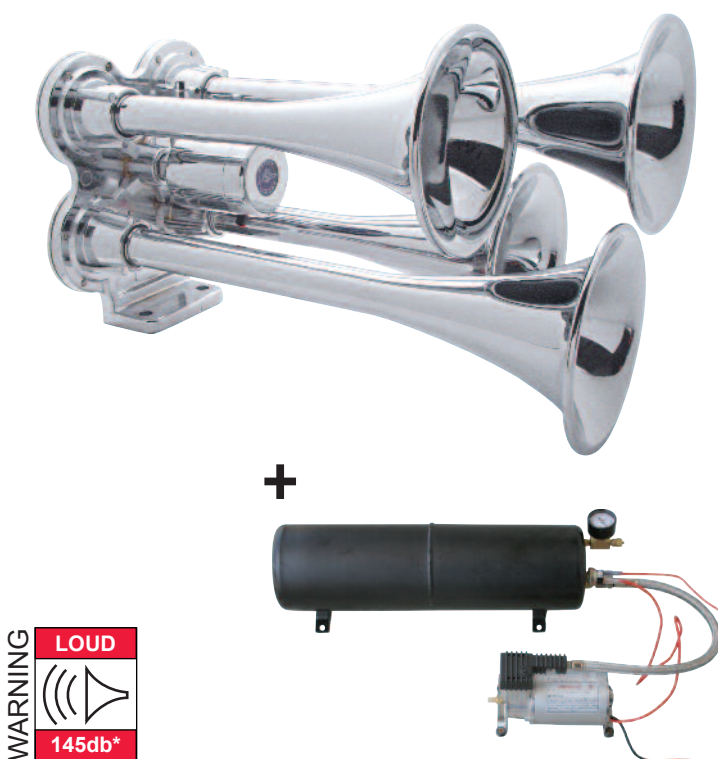

Chrome 5 Trumpet Train Horn

Description

- Chrome Heavy Duty 5 Trumpet Train Horn, Super Loud
- Sound Output: 155db \pm 10db*, 12V Heavy Duty Electric Solenoid Included
- Approximate Size: 17" L x 17" W x 15" H

Item Number	Description	Package	Pack
46131	5 Trumpet Train Horn	Boxed	1 Pc./Box



Unique 5 Trumpet Design

Chrome 4 Trumpet Train Horn

Description

- Chrome 4 Trumpet Train Horn, Super Loud
- Sound Output: 155db \pm 10db*, 12V Heavy Duty Electric Solenoid Included
- Approximate Size: 15 1/4" L x 11 1/2" W x 12" H

Item Number	Description	Pack
46130	4 Trumpet Train Horn	1 Pc./Box



Chrome 4 Trumpet Train Horn - Low Profile

Description

- Chrome 4 Trumpet Low Profile Train Horn, Super Loud
- Sound Output: 155db \pm 10db*, 12V Heavy Duty Electric Solenoid Included
- Approximate Size: 15 1/4" L x 15 3/4" W x 9 3/4" H

Item Number	Description	Pack
46143	4 Trumpet Low Profile Train Horn	1 Pc./Box



Chrome 3 Trumpet "DELUXE" Train Horn

Description

- Chrome "DELUXE" 3 Trumpet Train Horn, Super Loud
- Sound Output: 155db \pm 10db*, 12V Heavy Duty Electric Solenoid Included
- Approximate Size: 18 1/2" L x 14" W x 12" H

Item Number	Description	Pack
46120	3 Trumpet Deluxe Train Horn	1 Pc./Box



Heavy Duty Bracket

**Chrome 3 Trumpet "CLASSIC" Train Horn**

Description

- Chrome 3 Trumpet "CLASSIC" Train Horn, The Original Chrome Train Horn
- Sound Output: 155db \pm 10db*, 12V Heavy Duty Electric Solenoid Included
- Super Loud, Approximate Size: 18 1/2" L x 14" W x 13 1/2" H

Item Number	Description	Pack
46116	"CLASSIC" Train Horn	1 Pc./Box



Heavy Duty Bracket



Heavy Duty Bracket



Chrome 3 Trumpet Train Horn

Description

- Chrome 3 Trumpet Train Horn, Super Loud
- Sound Output: 145db ± 10db*, 12V Heavy Duty Electric Solenoid Included
- Approximate Size: 15 3/4" L x 12 1/2" W x 11 1/2" H

Item Number	Description	Pack
46129	Chrome 3 Trumpet Train Horn	1 Pc./Box



Chrome 3 Trumpet "Competition Series" Train Horn

Description

- Chrome "Competition Series" Train Horn, Super Loud
- Sound Output: 145db ± 10db*, 12V Heavy Duty Electric Solenoid Included
- The Best Train Horn in the Market, Super Loud
- Approximate Size: 15 1/2" L x 11 3/4" W x 11 1/2" H

Item Number	Description	Pack
46151	"Competition Series" Train Horn	1 Pc./Box



Black 3 Trumpet Train Horn

Description

- Black Standard Duty 3 Trumpet Train Horn, Super Loud
- Sound Output: 145db ± 10db*, 12V Heavy Duty Electric Solenoid Included
- Approximate Size: 15 3/4" L x 12 1/2" W x 11 1/2" H

Item Number	Description	Pack
46127	Black 3 Trumpet Train Horn	1 Pc./Box



* Sound output measurements are proximate estimations, actual sound levels will vary depending on air pressure applied, measurement techniques, and instruments used. Product specifications subject to change without notice.
 © 2012 United Pacific Industries, Carson, CA, All Rights Reserved

Chrome 8 Trumpet Horizontal Train HornDescription

- Chrome 8 Heavy Duty Horizontal Trumpet Train Horn, Super Loud
- Sound Output: 155db ± 10db*, 12V Heavy Duty Electric Solenoid Included
- Approximately Size: 26" L x 27 1/4" W x 4"H

Item Number	Description	Pack
46136	8 Trumpet - Long Trumpet on Left	1 Pc./Box
46137	8 Trumpet - Long Trumpet on Right	1 Pc./Box

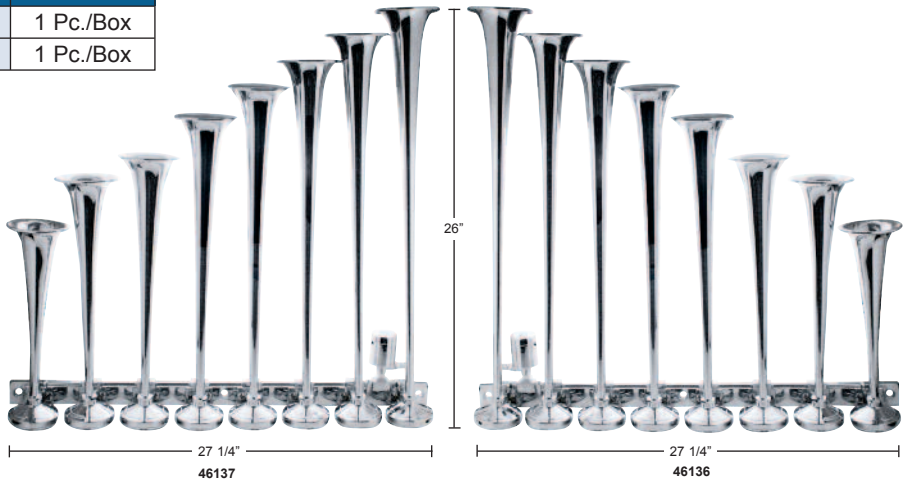
**Chrome 7 Trumpet Horizontal Train Horn**Description

- Chrome 7 Heavy Duty Horizontal Trumpet Train Horn, Super Loud
- Sound Output: 155db ± 10db*, 12V Heavy Duty Electric Solenoid Included
- Approximate Size: 24" L x 24" W x 4"H

Item Number	Description	Pack
46134	7 Trumpet - Long Trumpet on Left	1 Pc./Box
46135	7 Trumpet - Long Trumpet on Right	1 Pc./Box

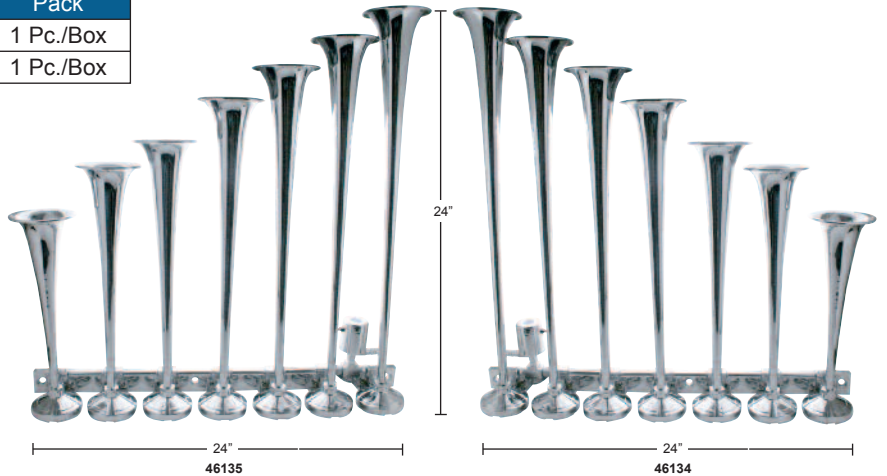
**Chrome 6 Trumpet Horizontal Train Horn**Description

- Chrome 6 Heavy Duty Horizontal Trumpet Train Horn, Super Loud
- Sound Output: 155db ± 10db*, 12V Heavy Duty Electric Solenoid Included
- Approximate Size: 23" L x 20 1/4" W x 4"H

Item Number	Description	Pack
46132	6 Trumpet - Long Trumpet on Left	1 Pc./Box
46133	6 Trumpet - Long Trumpet on Right	1 Pc./Box

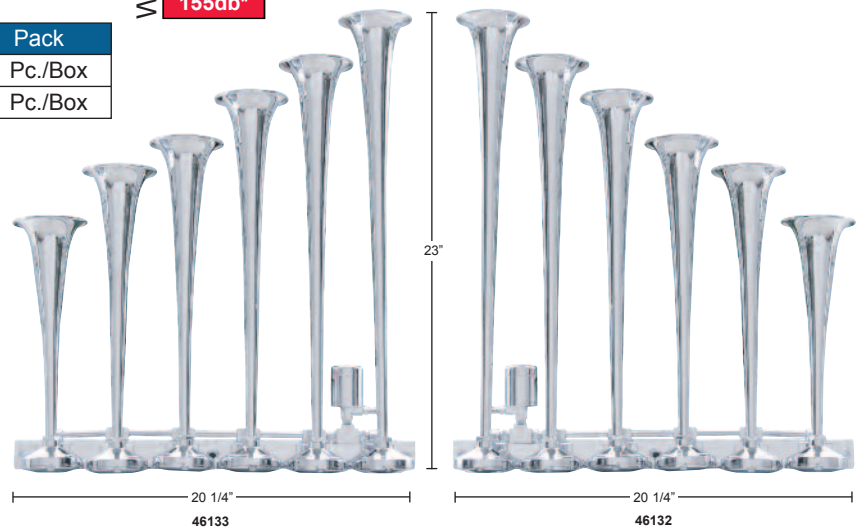



Chrome 3 Trumpet "CLASSIC" Train Horn

Description

- Chrome 3 Trumpet "CLASSIC" Train Horn with Trumpet Support Bracket
- Sound Output: 155db \pm 10db*, 12V Heavy Duty Electric Solenoid Included
- Approximate Size: 18 3/4" L x 17 1/2" W x 6 3/4" H, Long Trumpet on Left

Item Number	Description	Pack
46115	Classic Horizontal Train Horn	1 Pc./Box

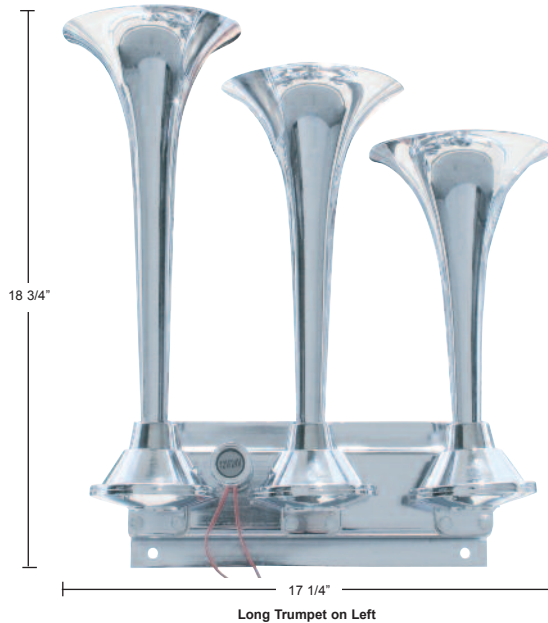

Chrome 3 Trumpet Train Horn - Long Trumpet on Left

Description

- Chrome 3 Heavy Duty Horizontal Trumpet Train Horn, Long Trumpet on Left
- Sound Output: 155db \pm 10db*, 12V Heavy Duty Electric Solenoid Included
- Approximate Size: 18 3/4" L x 17 1/4" W x 17" H, Super Loud

Item Number	Description	Pack
46145	3 Trumpet - Long Trumpet on Left	1 Pc./Box

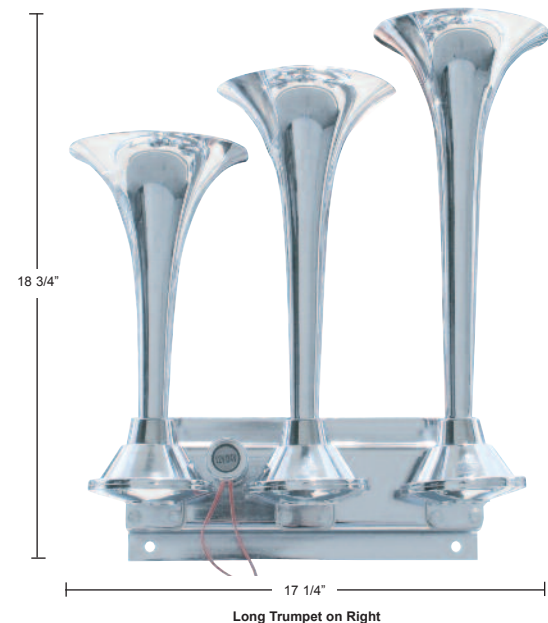

Chrome 3 Trumpet Train Horn - Long Trumpet on Right

Description

- Chrome 3 Heavy Duty Horizontal Trumpet Train Horn, Long Trumpet on Right
- Sound Output: 155db \pm 10db*, 12V Heavy Duty Electric Solenoid Included
- Approximate Size: 18 3/4" L x 17 1/4" W x 7" H, Super Loud

Item Number	Description	Pack
46146	3 Trumpet - Long Trumpet on Right	1 Pc./Box





Emergency Tone Horn

- Description**
- Chrome Emergency Tone Horn, 6" Diameter Trumpet
 - Replicate the Sound of Fire Trucks and Other Emergency Vehicles
 - Heavy Duty Construction with Trumpet Support Bracket
 - Approximate Size: 25 1/2" L x 6" W x 5 1/4" T

Item Number	Description	Pack
46174	Emergency Tone Horn	1 Pc./Box

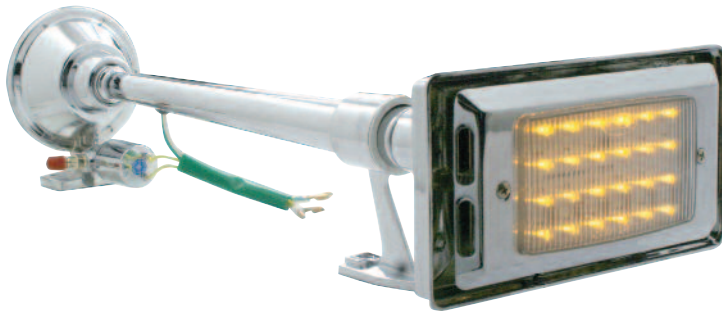

Chrome Single Trumpet Air Horn with LED

- Description**
- Single Trumpet Air Horn with 24 Amber LED
 - Includes: Horn with Light Base, Chrome Horn Cover and 24 Amber LED Light
 - Super Loud, Sound Output: 130db ± 10db, 12V Heavy Duty Electric Solenoid Included
 - Approximate Size: 19 1/3" L x 7 1/2" W x 4" H

Item Number	Description	Pack
46142	Single Train Horn with LED	1 Pc./Box

Components Available Separately

 <p>46124 Horn with Light Base Only LED Light & Cover Not Included</p>	 <p>46124-1 LED Horn Cover</p>	 <p>46122-1 24 Amber LED Light</p>
--	---	---

Electric Horn

Stainless Steel 2 Trumpet Electric Horn

- Description**
- Stainless Steel 2 Trumpet Electric Horn, 12 Volt Application
 - Super Loud, Sound Output: 120db ± 10db, 12V Heavy Duty Electric Solenoid
 - Approximate Size: 18" L x 8" W x 4" H, S.S. Horn Cover Included

Item Number	Description	Pack
46118	Dual Trumpet Electric Horn	1 Pc./Box



Chrome 4 Trumpet Mini Train Horn

- Description**
- Deluxe Chrome 4 Trumpet Mini Train Horn, Super Loud
 - Easy Installation. Sound Output: 130db ± 10db
 - Approximate Size: 12" L x 6 1/2" W x 6" H, 12V Heavy Duty Electric Solenoid

Item Number	Description	Package	Pack
46123	4 Trumpet Mini Train Horn	Boxed	1 Pc./Box



Chrome 6 Trumpet Mini Train Horn

- Description**
- Deluxe Chrome 6 Trumpet Mini Train Horn, Super Loud
 - Easy Installation. Sound Output: 130db ± 10db
 - Approximate Size: 15" L x 9 3/4" W x 12 1/2" H, 12V Heavy Duty Electric Solenoid

Item Number	Description	Package	Pack
46139	6 Trumpet Mini Train Horn	Boxed	1 Pc./Box



Recommended Accessories



46118-1

Specialty Horn and Whistle

Electric Bull Horn

Description

- Electric Bull Horn, Simulates the Sound of an Angry Bull, Red Steel Housing
- 12 Volt Application, Approximate Size: 9" L x 7 3/8" W x 5 3/8" H

Item Number	Description	Package	Pack
46103	Bull Horn	Boxed	1 Pc./Box



Bull Horn

Electric Bull Horn with Control Lever

Description

- Electric Bull Horn with Control Lever
- Simulate the Sound of an Angry Bull, Approx. Size: 9" L x 7 3/8" W x 5 3/8" H

Item Number	Description	Package	Pack
46102	Bull Horn	Boxed	1 Pc./Box



Ah-Ooo-Gah Horn

Description

- Ah-Ooo-Gah Horn with Chrome Body, Vintage Car Horn
- Sound Output: 110db ± 10db*, Approximate Size: 9" L x 5" W x 5" H

Item Number	Description	Package	Pack
46138	Ah-ooo-gah Horn	Carded	1 Pc./Card



Train Whistle

Description

- Brass Train Whistle, Simulates the Sound of a Vintage Train Whistle
- Available in Chrome or Brass Finish
- Approximate Size: 5 1/2" L x 5" W x 13 1/8" H

Item Number	Description	Package	Pack
46107	Chrome Train Whistle	Boxed	1 Pc./Box
46108	Brass Train Whistle	Boxed	1 Pc./Box



Wolf Whistle

Description

- Wolf Whistle, Updated Version of the Classic Air Driven Wolf Whistle
- Simulates the Sound of a Whistle to Attract and Compliment the Opposite Sex
- Approximate Size: 6" L x 3 1/2" W x 4 1/2" H

Item Number	Description	Package	Pack
46128	Wolf Whistle	Boxed	1 Pc./Box



* Sound output measurements are proximate estimations, actual sound levels will vary depending on air pressure applied, measurement techniques, and instruments used. Product specifications subject to change without notice.
 © 2012 United Pacific Industries, Carson, CA, All Rights Reserved

Horn Cover

Description

- Chrome or Stainless Steel Horn Cover
- 4 Welded Snap-In Mounting Clips, Available in 3 Different Styles
- Fits 4 1/4" to 8" Diameter Trumpets, Please Refer to Application Chart

Dome Horn Cover

Item Number	Horn Cover Application	Finish	Pack
10301	5 1/2" to 6" Dia. Horn	Chrome	1 Pc.
10302	6 1/4" to 7" Dia. Horn	Chrome	1 Pc.
10303	7 1/4" to 7 1/2" Dia. Horn	Chrome	1 Pc.
10304	7 3/4" to 8" Dia. Horn	Chrome	1 Pc.
46118-1	4 1/4" to 4 1/2" Dia. Horn	Stainless	1 Pc.
21301	5 1/2" to 6" Dia. Horn	Stainless	1 Pc.
21302	6 1/4" to 7" Dia. Horn	Stainless	1 Pc.
21303	7 1/4" to 7 1/2" Dia. Horn	Stainless	1 Pc.



Dome Horn Cover



Pointed Horn Cover



Rectangular Horn Cover

Pointed Horn Cover

Item Number	Horn Cover Application	Finish	Pack
10310	5 1/2" to 6" Dia. Horn	Chrome	1 Pc.
10311	6 1/4" to 7" Dia. Horn	Chrome	1 Pc.
10312	7 1/4" to 7 1/2" Dia. Horn	Chrome	1 Pc.

Rectangular Horn Cover

Item Number	Horn Cover Application	Finish	Pack
21305	4 5/8" x 7 3/8" Horn Bell	Chrome	1 Pc.



46116 Replacement Trumpet

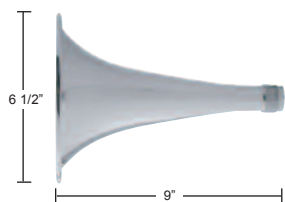

Small Trumpet
46116-4



Medium Trumpet
46116-3



Large Trumpet
46116-2



46129 Replacement Trumpet



Small Trumpet
46129-1



Medium Trumpet
46129-2



Large Trumpet
46129-3



46127 Replacement Trumpet

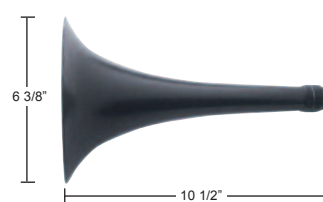

Small Trumpet
46127-1



Medium Trumpet
46127-2



Large Trumpet
46127-3

Electric Solenoid Valve

Description

- Electric Solenoid Valve for United Pacific Train Horn, 12V Operation
- UP Item # 46127-4 Only Fits UP Item # 46127, 46129, and 46130 Train Horn

Item Number	Description	Pack
46116-1	12V Electric Solenoid	1 Pc.
46127-4	12V Solenoid, Fits UP # 46127, 46129, 46130	1 Pc.



Train Horn Diaphragm

Description

- Replacement Diaphragm for 3 Trumpet Train Horn
- Only Fits United Pacific Train Horn (UP Item # 46127 and 46129)

Item Number	Description	Package	Pack
46127-5	Horn Diaphragm	Bulk	1 Pc.

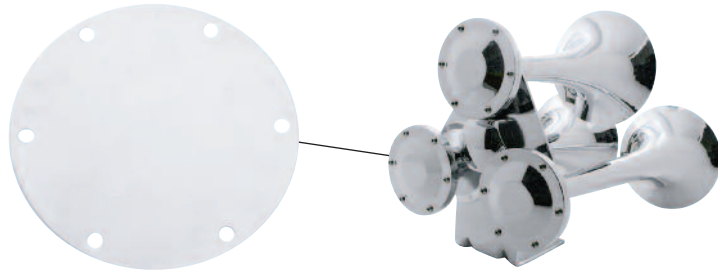

Train Horn Mounting Hardware Kit

Description

- Mounting Hardware Kit for Train Horn
- Kit Includes 1 Pad, 3 Sets of Stainless Steel Screws and Washers

Item Number	Description	Package	Pack
46127HW	Train Horn Hardware Kit	Bulk	1 Set

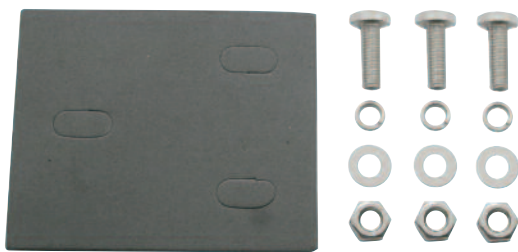

Horn Button Switch

Description

- Universal Horn Button Switch
- Chrome Plated Body with Black Knob
- Universal Application, Perfect for Autos, Trucks, Boats, and RVs

Item Number	Description	Package	Pack
40028	Horn Button Switch	Bulk	1 Pc.



Air Valve Lever Set

Chrome Air Valve Lever Set

Description

- Chrome Air Valve Lever for Train Horns
- Includes Air Valve Lever and Stand
- Available with 4", 9" or 11" Tall Stand

Item Number	Description	Package	Pack
46106	4" Air Valve Lever Set	Carded	1 Set/Card
46111	9" Air Valve Lever Set	Carded	1 Set/Card
46112	11" Air Valve Lever Set	Carded	1 Set/Card



Chrome Air Valve Lever

Description

- Chrome Air Valve Lever for United Pacific Air Valve Lever Set
- Manual Air Valve Lever for Train Horn

Item Number	Description	Package	Pack
46111-2	Air Valve Lever	Boxed	1 Pc./Box



Chrome Air Valve Stand

Description

- Chrome Air Valve Stand for United Pacific Air Valve Lever Set
- Available in 9" or 11" Tall Stand

Item Number	Description	Package	Pack
46111-1	9" Stand	Boxed	1 Pc./Box
46112-1	11" Stand	Boxed	1 Pc./Box

Air Compressor & Tank Kit

Description

- Heavy Duty Compressor and Tank System for High Pressure Air/Train Horns
- Heavy Duty, High Volume Turbo Compressor with 5.5 Liter Extended Tank That Permits for Prolonged Horn Operation
- On-Board Air System for All 12 Volt Vehicles, Auto On/Off Switch
- Sold in Sets, Set Includes 1 Air Compressor and 1 Air Tank

Item Number	Description	Package	Pack
46140	Air Compressor Kit	Box	1 Set/Box

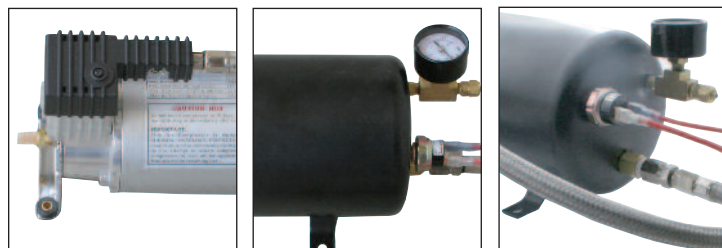

Compressor Auto Off: 114 PSI
Compressor Auto On: 85 PSI

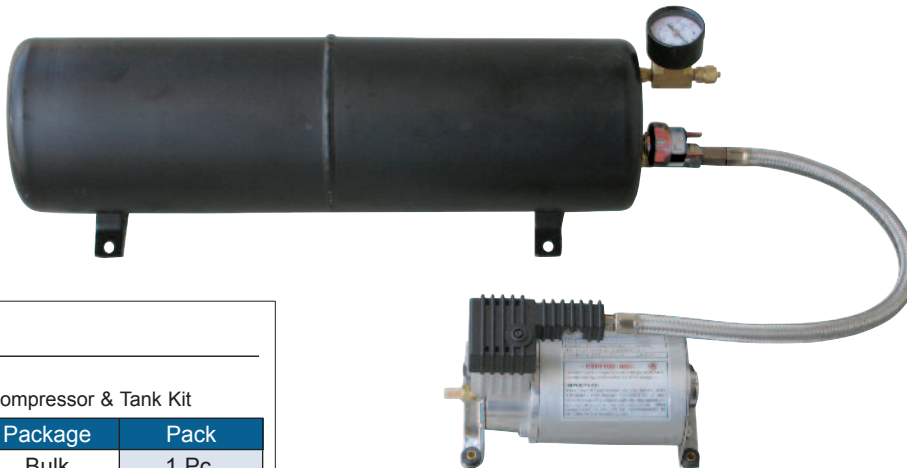

Deluxe Air Compressor

Description

- Heavy Duty Air Compressor
- Replacement Compressor for United Pacific Air Compressor & Tank Kit

Item Number	Description	Package	Pack
46147	Air Compressor	Bulk	1 Pc.



Air Pressure Switch

Description

- Air Pressure Switch Turns on the Compressor when Tank Pressure is Below 85 PSI and Turn Off the Compressor when Tank Pressure is Above 114 PSI
- 1/4 Inch Pipe Threads, 1/4" Push On Male Terminals

Item Number	Description	Package	Pack
46126	Air Pressure Switch	Bulk	1 Pc.

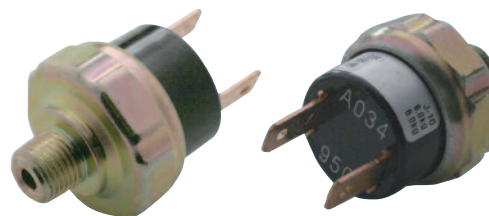

Auto Off: 114 PSI
Auto On: 85 PSI

Air Compressor

Description

- Heavy Duty Air Compressor
- Specially Designed for Train Horns
- 12 Volt Operation, 150 Max PSI, up to 39 LPM

Item Number	Description	Package	Pack
46125	Air Compressor	Boxed	1 Pc./Box



Air Storage Tank

Description

- All Metal Black 5.5 Liter Air Storage Tank

Item Number	Description	Package	Pack
46148	5.5 Liter Air Storage Tank	Bulk	1 Pc.



High Pressure Air Hose

Description

- 19 1/2" Long High Pressure Air Hose with Steel Braid
- High Quality 1/4" Brass Connectors

Item Number	Description	Package	Pack
46149	High Pressure Air Hose	Bulk	1 Pc.



Heavy Duty Air Blow Gun Kit

Description

- Heavy Duty Chrome Air Blow Gun Kit
- Cold Temperature Resistant Nylon-12 Hose, Recoils into Smaller Dimension for Easy Storage
- Item # 90000 Includes Snap-In "T" Fitting, Extra Nozzle, and Blow Gun
- Item # 90000-1 Includes Snap-In "T" Fitting

Item Number	Description	Package	Pack
90000	Deluxe Air Blow Gun Kit	Carded	1 Set/Card
90000-1	Replacement Recoil Air Hose	Carded	1 Set/Card

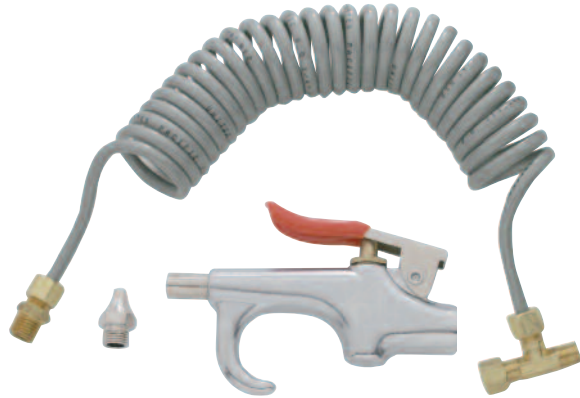

Heavy Duty Air Blow Gun

Description

- Heavy Duty Chrome Air Blow Gun with 1/4" Connector
- Includes Extra Nozzle

Item Number	Description	Package	Pack
90003	Air Blow Gun	Carded	1 Pc./Card



Recoil Air Hose

Description

- Cold Temperature Resistance Nylon-12 Hose, Recoils into Smaller Dimension for Easy Storage
- Perfect as a Fifth Wheel Air Slide Coil
- With 1/4" Pipe Male Connector on Each End

Item Number	Description	Package	Pack
89999	Recoil Air Hose	Bulk	1 Pc.



Brass Connectors

Description

- 1/4" Brass Connector
- Universal Application

Item Number	Description	Size	Pack
90004	Female Brass Pipe Tee	1/4"	Bulk = 1 Pc.
90005	Brass Close Nipple	1/4"	Bulk = 1 Pc.
90006	Brass MIP Connector	1/4"	Bulk = 1 Pc.



90004



90005



90006

Hot Items

High Power LED Work Light



39688

6 High Power LED Work Light



39979

6 High Power LED Spot/Utility Light



39901

6 High Power LED Work Light



39993

5 High Power LED Rectangular Auxiliary/Utility Light



37634B

12 High Power LED Rectangular Work/Utility Light



37622B

6 High Power LED Square Work/Utility Light



37597

9 High Power LED Flood Light



37598

9 High Power LED Spot Light

TERMS & CONDITIONS / ORDERING GUIDELINES / FREIGHT

IMPORTANT: PLEASE REVIEW CAREFULLY

New Accounts

Initial minimum buy-in is \$2,000 (or to be determined by United Pacific Industries, UPI hereafter). All initial orders must be prepaid in advance by Cashier's Check or VISA/MC. All new/potential accounts must complete a UPI "New Customer Info/Credit Form" and follow the Dealer Qualification Instructions. Upon completion of the credit application, approved accounts will be assigned payment terms of NET 30 Days (from invoice date). Accounts denied a credit line will be required to prepay in advance by Cashier's Check or VISA/MC.

Payment Terms:

Term Accounts

Accounts with NET 30 Days terms are required to submit payment within the 30 days from the date of invoice. Acceptable forms of payment include checks, ACH (Automated Clearing House), or wire transfer.

A service charge of 1.5% per month will be imposed on invoices not paid within the 30 day term. Delinquent accounts will be required to pay Cash-In-Advance (CIA). Checks will be accepted but orders will not be released until the check is cleared by the bank. Past due invoices will delay current orders. Please check with UPI on your account status when placing an order.

Credit Cards

Accounts denied credit terms may pay by Visa or MasterCard. Credit card will be charged upon shipment. Credit card payments will not be accepted once an order has been shipped. UPI does not accept American Express or Discover card.

COD

A \$9.00 fee will be assessed per COD box for all FedEx/UPS COD shipments. Truck COD shipment fees are to be determined later by trucking company.

Returned Checks:

A \$30 NSF (Non Sufficient Fund) fee will be assessed on each incidence a check is returned to UPI.

ORDERING GUIDELINES

Placing Orders: New orders may be placed by any of the following methods

1. Fax: (310) 638-6287
2. E-mail: sales@uapac.com

3. Telephone: In order to minimize errors, customers are encouraged to submit their orders by fax or email. Telephone orders should be limited to smaller orders such as add-ons to orders already submitted and/or fill-ins occurring between larger restocking orders.

Changes to Orders:

Whenever possible, revisions to orders - additions or deletions of items - should also be submitted via fax or email to reduce the possibility of errors.

Additions/Deletion of items will only be accepted within 48 hours after the initial order date and/or before 12:00PM on the date of the shipment.

Additions of items placed after the 48 hours time period will be considered a new order and adhere to a new order freight prepaid policy. Deletions of item cannot happen after the 48 hours time period and/or after 12:00PM on the date of the shipment. Please note additions and/or deletions of items will delay the shipment date.

Canceling Orders:

Cancellation of orders must be submitted via fax or email within 24 hours of the order date. If the order has already shipped it will be the customers responsibility to return the order at the customers own expense. A restocking fee may apply, please see "Return" policy for further detail.

Backorders:

Customers have the option of having their backorders shipped or cancelled. Backorders resulting from a freight prepaid qualifying order will be shipped freight prepaid. UPI reserves the right to cancel backorders that are 6 months or older from the initial invoice date.

Minimum Order:

A minimum order of \$50.00 is required. Orders below \$50.00 will be assessed a minimum order fee of \$10.00.

Packaging:

A 10% service charge will be added to orders with special packaging or UPC barcoding requirements.

Lead Times:

Standard lead time for all United Pacific orders is 1-3 business days from the receipt of the purchase order. Larger orders may require a lead time of up to 5 business days. Transit time of 3-5 business days must be considered when placing orders. UPI cannot be responsible for delays in shipment after an order leaves our warehouse. UPI will work to resolve delays with freight forwarding firms, however, delays do arise from time to time due to weather and unforeseen circumstances beyond UPI's control. Express order are exempted; please view Freight/Shipping Policy for further detail.

Order Confirmation:

United Pacific will acknowledge receipt of orders by email/fax/telephone within 1 business day of receipt. If confirmation is not received, please contact UPI to ensure your order was received.

FREIGHT

Prepaid Freight:

Stock orders between \$50 and \$999.99 (US Lower 48 States), **\$50 and \$2499.99 (Alaska and Hawaii)**, **\$50 and \$1499.99 (Canada)**, [all price net US\$], will be shipped FOB Carson, California. Stock orders of \$1,000 (US Lower 48 States), **\$2500 (Alaska and Hawaii)**, **\$1500 (Canada)**, [based on UPI current pricing], or more will be shipped Freight Prepaid Ground to a single location only. (See exception for Oversize Items*). *Express Air orders, Special Net Pricing orders, and Special Quote Pricing orders are excluded.* United Pacific reserves the right to select the carrier of our choice. Customers may select the carrier of their choice at their own expense, negotiated rates and insurance. If customers elect to choose their own freight carrier, orders will be shipped via FREIGHT COLLECT.

***Oversize Item Freight Policy** - Applies to PB 379 Front Fenders, 60" or longer exhaust, and 18" or longer Saddle Boxes. 2 Options:

1. Freight will be prepaid by United Pacific if the total order of all items exceeds \$4,000 (US Lower 48 States) or **\$5000 (Hawaii, Alaska and Canada)**, [all price net US\$]. There will not be additional charges for these items included on the order.
2. Freight will be prepaid by United Pacific if a customer orders a total of \$2,500 (US Lower 48 States) or **\$3500 (Hawaii, Alaska and Canada)**, [all price net US\$], of PB 379 fenders, 60" or longer exhaust, and/or 18"+ Longer Saddle Boxes only. If the order is below \$2,500 (US Lower 48 States) or **\$3500 (Hawaii, Alaska and Canada)**, United Pacific will add freight charges to the order for the oversize items.

Will Call Orders:

Will Call orders can be picked up 2 - 4 hours after placing the order. Customers should always call ahead to confirm when order will be ready to pick up.

SHIPPING POLICY / CLAIMS

IMPORTANT: PLEASE REVIEW CAREFULLY

SHIPPING POLICY

International Shipments:

Shipments to locations outside the continental United States will be shipped to the customer's shipping agent or broker within the continental United States in accordance with the US freight policy. International customers will be responsible for the duties and taxes of their respective country.

Express Orders:

All express orders, such as Next Day, Second Day, 3 Day Service & Will Call, must be faxed/emailed. Order confirmation will be faxed to the customer for final approval. If confirmation is not received, please contact UPI to ensure your order was received. Customers are required to sign off on express orders and fax confirmation back to UPI. Cut off for express order is 12:00PM. Express orders received after 12:00PM may or may not ship the same day. Please call UPI to confirm projected shipping date or will call time.

Due to the high cost of express shipments, customer may request UPI to call to confirm freight charges. If customer does not request confirmation, UPI will ship the express order.

Drop Shipments:

All drop shipment orders will be assessed a \$10.00 processing fee. Drop shipment processing fee will be automatically added to the invoice without notice. All drop shipment orders must be faxed in. No freight allowance or prepaid freight will be permitted for any drop shipments, thus, all drop ship orders, regardless of order size, are FOB Carson, CA.

CLAIMS

General Policy:

All claims (Shortage, Mis-Shipped, Damage, Overage, Customer Error & Billing Error) must be submitted to UPI within 3 business days of the receipt of shipment. Claims submitted beyond 3 business days of the receipt of shipment will be voided by UPI.

On all shipments, the person who signs and receives the shipment is responsible for noting on the Bill of Lading, in writing, whether any boxes arrived damaged or shorted. Failure to do so will void all claim rights between all parties. UPI will have no recourse against the trucking company if customer does not note any damages or shortages on the Bill of Lading.

The customers receiving department must count and sign for the exact number of boxes received. Failure to follow the above instructions will void all claim rights between all parties.

Shortages / Mis-Ships / Damages

While UPI strives to fill every order with 100% accuracy, on occasion an item may get shipped in error or get damaged during shipping. In the event this occurs, please follow the process below. Note: This type of claim must be reported to UPI within three (3) business days of receiving the order.

- Contact the United Pacific office to initiate the claim. To make it easy for you we have two acceptable methods for requesting the claim:
 - * By e-mail : returns@uapac.com
 - * By fax : **(310) 638-6287**
 - * **Note: To ensure you receive a timely credit, we cannot accept claim requests by phone.**
- You will be required to provide the following information:
 - * Your business name
 - * Contact name and telephone number (in case we have questions)
 - * Date the order was received

- * A copy of the Packing List / Invoice noting the item number and quantity that was shipped in error or damaged during shipping.
- * Special instructions you have for us.

- UPI will send a return label so you can ship the items back.
- Once we receive the miss-shipped/damaged item(s) a credit will be issued to your account on the next billing cycle.
- Shortages will be credit to the Customers' account, unless customer would like the shortages replaced.

Overages:

UPI strives to provide our customers with the best customer service and products, in turn we would greatly appreciate any help from customer in notifying UPI of any shipping overages. Customers will be offered the option of retaining the merchandise or returning the merchandise to UPI at UPI's expense. If the items are to be returned, an RMA number and return shipping label will be provided.

Customer Errors:

Any item or quantity ordered in error by the customer may be returned by contacting UPI for a RMA No.

- To make it easy for you we have two acceptable methods for requesting the RMA:
 - * By e-mail: returns@uapac.com
 - * By fax: **(310) 638-6287**
 - * **Note: To ensure you receive a timely RMA credit, we cannot accept RMA requests by phone.**
- You will be required to provide the following information:
 - * Your business name
 - * Contact name and telephone number (in case we have questions)
 - * A list of the items number and quantity ordered in error
 - * Special instructions you have for us
- UPI will review the request to ensure the products are within the return period.
- Once we have validated the request, United Pacific will issue an RMA number to the customer. In issuing the RMA approval, the following conditions will apply :
 - * Returned items are subject to a 20% re-stocking fee.
 - * Return shipping costs are the responsibility of the customer.
 - * Items must not have any retail/price sticker on exterior packaging or they will be returned to the customer at customer's expense and no credit given.
 - * Items must be in good condition with original packaging intact or they will be returned to the customer at customer's expense and no credit given.
 - * Allow up to 30 days for the credit to be issued from the time the returned items are received.

Billing Errors:

Billing errors should be reported to UPI within 3 business days of invoice receipt. Customers are asked to provide the invoice number, part number, and quantities in question. Once verified, UPI will issue a credit or an invoice for the difference in billing error.

WARRANTY POLICY / RETURNS

IMPORTANT: PLEASE REVIEW CAREFULLY

WARRANTY POLICY

General Policy:

UPI offers a NO HASSLE WARRANTY RETURN policy to all our customers. Warranty claims can only be submitted through an authorized UPI Distributor. UPI warranty is not transferable and applies to the original installation and purchase only. In no event shall UPI be liable for incidental or consequential damages, nor shall UPI be liable for any claims or damages arising out of or connected with the UPI warranty exceed the purchase price of the products. There are no warranties, expressed or implied (including any warranty of merchantability or fitness) that extend beyond this warranty. The warranty does not apply to costs associated with the loss of use of the product, loss of time, inconvenience, commercial loss, incidental or consequential damages. UPI reserves the right to alter the designs of products without assuming any obligation to modify previously manufactured products and will only replace warrantied products with redesigned products.

Warranty does not apply to merchandise that has been drilled, cut, welded, modified in any way or installed contrary to normal installation and usage. In addition, UPI cannot be held liable for damages caused by road hazards, accidents, misuse, neglect, abuse or corrosive environments including acid washes and highway snow/ice chemicals which can cause discoloration and corrosion in aluminum, chrome, stainless steel and light products. UPI reserves the right to credit returned merchandise at the initial purchase price or at the current selling price, which price ever is lower.

Aluminum / Chrome / Stainless Steel Products:

All aluminum, chrome, and stainless steel products carry a limited 6 month warranty (from invoice date) against defects in material or workmanship.

LED

Please refer to the Master Lighting Product Catalog for more detail.

RETURNS

General Policy:

All returns must be authorized by UPI. All return requests must be faxed or e-mailed (returns@uapac.com) A RMA number (Return Merchandise Authorization Number) will be provided. Returns not possessing a valid RMA number are subject to rejection and will be returned to sender at the customer's expense.

All customers are encouraged to use the Warranty RMA Claim Form.

Defective Goods / Warranty Return:

UPI offers our customers a No Hassle Warranty Return. Please follow the instructions below for requesting a RMA for defective goods:

- If any warranty issues occur, simply contact the UPI for RMA number To make it easy for you we have two acceptable methods for requesting the RMA:
 - * By e-mail: returns@uapac.com
 - * By fax: (310) 638-6287

*** Note: To ensure you receive a timely RMA credit, we cannot accept RMA requests by phone.**
- You will be required to provide the following information:
 - * Your business name
 - * Contact name and telephone number (in case we have questions)
 - * A list of the defective item number and quantity with the nature/reason of the defect
 - * Special instructions you have for us

* The enclosed fax form may be used for your convenience to request an RMA

- UPI will review the request to ensure the products are within the stated warranty period.
- Once we have validated the warranty items, a RMA confirmation, listing the items and cost will be faxed to the customer within 3 business days. UPI will process the credit to your account within 30 days.

Note: There will be no need to return the warranty product to us. However, from time to time, UPI may require some warranty products to be shipped back so we may analyze the cause of the failure. All warranty products that are required to be shipped back will be freight prepaid by UPI.

Stock Return

United Pacific Industries encourages all customers to regularly monitor the sales volume and stock level of their inventory items. As sales trends may slow the movement of specific items, our hope is that those items are featured as "close-out specials" as to minimize stock returns. We also understand that the customer, from time to time, may accumulate over-stock items and desire to return those. Therefore, we have adopted the following policy below.

NOTE:

- * Items must have been purchased by the dealer requesting the stock return.
- * Items must have been purchased within the preceding 12 months.
- * Items that have been discontinued will not be considered for return.

- Contact the United Pacific office for RMA number We have 2 acceptable methods for requesting the RMA:

By e-mail : returns@uapac.com

By fax : (310) 638-6287

Note: To ensure you receive a timely RMA credit, we cannot accept RMA requests by phone.

- You will be required to provide the following information:

- * Your business name
- * Contact name and telephone number (in case we have questions)
- * A list of defective items: Item numbers and quantity of each
- * Special instructions you have for us

- Your claim will be reviewed within 5 business days and you will be contacted by your sales representative who will discuss solutions to liquidate these slow moving items.
- In the event United Pacific and the customer agree to a credit in lieu of returning the items, this credit will be issued within 10 business days.
- In the event items are returned by the customer, United Pacific will issue an RMA number to the customer. In issuing the RMA approval, the following conditions will apply:
 - * Returned items are subject to a 20% re-stocking fee.
 - * Return shipping costs are the responsibility of the customer.
 - * Items must not have any retail/price sticker on exterior packaging or they will be returned to the customer at customer's expense and no credit given.
 - * Items must be in good condition with original packaging intact or they will be returned to the customer at customer's expense and no credit given.
 - * Allow up to 30 days for the credit to be issued from the time the returned items are received
- Stock returns may be requested throughout the year and are subject to a maximum of 5% of prior year annual purchases.

DISCLAIMER

United Pacific Industries reserves the right to amend or update our Policies & Procedures without notice.



PRODUCT INDEX

Item No.	Page No.	Item No.	Page No.	Item No.	Page No.	Item No.	Page No.	Item No.	Page No.	Item No.	Page No.
10301	10	46137	6								
10302	10	46138	9								
10303	10	46139	8								
10304	10	46140	12								
10310	10	46142	8								
10311	10	46143	3								
10312	10	46145	7								
21301	10	46146	7								
21302	10	46147	12								
21303	10	46148	12								
21305	10	46149	12								
40028	11	46151	5								
46102	9	46170	2								
46103	9	46172	2								
46106	11	46173	2								
46107	9	46174	8								
46108	9	46175	2								
46111	11	89999	13								
46111-1	11	90000	13								
46111-2	11	90003	13								
46112	11	90004	13								
46112-1	11	90005	13								
46115	6	90006	13								
46116	4										
46116-1	11										
46116-2	10										
46116-3	10										
46116-4	10										
46118	8										
46118-1	8,10										
46120	4										
46122-1	8										
46123	8										
46124	8										
46124-1	8										
46125	12										
46126	12										
46127	5										
46127-1	10										
46127-2	10										
46127-3	10										
46127-4	11										
46127-5	11										
46127HW	11										
46128	9										
46129	5										
46129-1	10										
46129-2	10										
46129-3	10										
46130	3										
46131	3										
46132	6										
46133	6										
46134	6										
46135	6										
46136	6										